

TASCAM

TEAC Professional Division

D00410900A

DA-40

Digital Audio Tape Deck

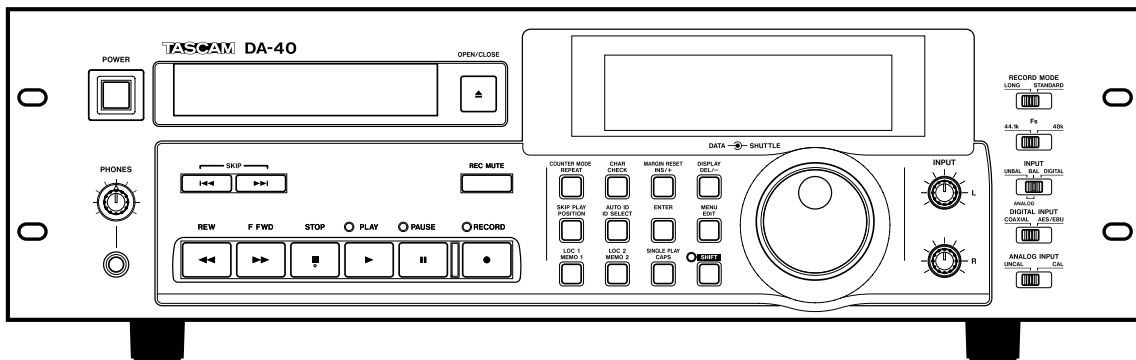

OWNER'S MANUAL



CAUTION: TO REDUCE THE RISK OF ELECTRIC SHOCK, DO NOT REMOVE COVER (OR BACK). NO USER-SERVICEABLE PARTS INSIDE. REFER SERVICING TO QUALIFIED SERVICE PERSONNEL.



The lightning flash with arrowhead symbol, within an equilateral triangle, is intended to alert the user to the presence of uninsulated "dangerous voltage" within the product's enclosure that may be of sufficient magnitude to constitute a risk of electric shock to persons..



The exclamation point within an equilateral triangle is intended to alert the user to the presence of important operating and maintenance (servicing) instructions in the literature accompanying the appliance.

This appliance has a serial number located on the rear panel. Please record the model number and serial number and retain them for your records.
 Model number _____
 Serial number _____

WARNING: TO PREVENT FIRE OR SHOCK HAZARD, DO NOT EXPOSE THIS APPLIANCE TO RAIN OR MOISTURE.

Important Safety Precautions

IMPORTANT (for U.K. Customers)

DO NOT cut off the mains plug from this equipment.

If the plug fitted is not suitable for the power points in your home or the cable is too short to reach a power point, then obtain an appropriate safety approved extension lead or consult your dealer.

If nonetheless the mains plug is cut off, remove the fuse and dispose of the plug immediately, to avoid a possible shock hazard by inadvertent connection to the mains supply.

If this product is not provided with a mains plug, or one has to be fitted, then follow the instructions given below:

IMPORTANT: The wires in this mains lead are coloured in accordance with the following code:

GREEN-AND-YELLOW : EARTH
BLUE : NEUTRAL
BROWN : LIVE

WARNING: This apparatus must be earthed.

As the colours of the wires in the mains lead of this apparatus may not correspond with the coloured markings identifying the terminals in your plug proceed as follows:

The wire which is coloured GREEN-and-YELLOW must be connected to the terminal in the plug which is marked by the letter E or by the safety earth symbol \perp or coloured GREEN or GREEN-and-YELLOW.

The wire which is coloured BLUE must be connected to the terminal which is marked with the letter N or coloured BLACK.

The wire which is coloured BROWN must be connected to the terminal which is marked with the letter L or coloured RED.

When replacing the fuse only a correctly rated approved type should be used and be sure to re-fit the fuse cover.

IF IN DOUBT — CONSULT A COMPETENT ELECTRICIAN.

For U.S.A

TO THE USER

This equipment has been tested and found to comply with the limits for a Class A digital device, pursuant to Part 15 of the FCC Rules. These limits are designed to provide reasonable protection against harmful interference when the equipment is operated in a commercial environment. This equipment generates, uses, and can radiate radio frequency energy and, if not installed and used in accordance with the instruction manual, may cause harmful interference to radio communications.

Operation of this equipment in a residential area is likely to cause harmful interference in which case the user will be required to correct the interference at his own expense.

CAUTION

Changes or modifications to this equipment not expressly approved by TEAC CORPORATION for compliance could void the user's authority to operate this equipment.

For the consumers in Europe

WARNING

This is a Class A product. In a domestic environment, this product may cause radio interference in which case the user may be required to take adequate measures.

Pour les utilisateurs en Europe

AVERTISSEMENT

Il s'agit d'un produit de Classe A. Dans un environnement domestique, cet appareil peut provoquer des interférences radio, dans ce cas l'utilisateur peut être amené à prendre des mesures appropriées.

Für Kunden in Europa

Warnung

Dies ist eine Einrichtung, welche die Funk-Entstörung nach Klasse A besitzt. Diese Einrichtung kann im Wohnbereich Funkstörungen verursachen ; in diesem Fall kann vom Betreiber verlangt werden, angemessene Maßnahmen durchzuführen und dafür aufzukommen.

IMPORTANT SAFETY INSTRUCTIONS

CAUTION:

- Read all of these Instructions.
- Save these Instructions for later use.
- Follow all Warnings and Instructions marked on the audio equipment.

- 1) Read Instructions** — All the safety and operating instructions should be read before the product is operated.
- 2) Retain Instructions** — The safety and operating instructions should be retained for future reference.
- 3) Heed Warnings** — All warnings on the product and in the operating instructions should be adhered to.
- 4) Follow Instructions** — All operating and use instructions should be followed.
- 5) Cleaning** — Unplug this product from the wall outlet before cleaning. Do not use liquid cleaners or aerosol cleaners. Use a damp cloth for cleaning.
- 6) Attachments** — Do not use attachments not recommended by the product manufacturer as they may cause hazards.
- 7) Water and Moisture** — Do not use this product near water — for example, near a bath tub, wash bowl, kitchen sink, or laundry tub; in a wet basement; or near a swimming pool; and the like.
- 8) Accessories** — Do not place this product on an unstable cart, stand, tripod, bracket, or table. The product may fall, causing serious injury to a child or adult, and serious damage to the product. Use only with a cart, stand, tripod, bracket, or table recommended by the manufacturer, or sold with the product. Any mounting of the product should follow the manufacturer's instructions, and should use a mounting accessory recommended by the manufacturer.
- 9) A product and cart combination** should be moved with care. Quick stops, excessive force, and uneven surfaces may cause the product and cart combination to overturn.



10) Ventilation — Slots and openings in the cabinet are provided for ventilation and to ensure reliable operation of the product and to protect it from overheating, and these openings must not be blocked or covered. The openings should never be blocked by placing the product on a bed, sofa, rug, or other similar surface. This product should not be placed in a built-in installation such as a bookcase or rack unless proper ventilation is provided or the manufacturer's instructions have been adhered to.

11) Power Sources — This product should be operated only from the type of power source indicated on the marking label. If you are not sure of the type of power supply to your home, consult your product dealer or local power company. For products intended to operate from battery power, or other sources, refer to the operating instructions.

12) Grounding or Polarization — This product may be equipped with a polarized alternating-current line plug (a plug having one blade wider than the other). This plug will fit into the power outlet only one way. This is a safety feature. If you are unable to insert the plug fully into the outlet, try reversing the plug. If the plug should still fail to fit, contact your electrician to replace your obsolete outlet. Do not defeat the safety purpose of the polarized plug.

13) Power-Cord Protection — Power-supply cords should be routed so that they are not likely to be walked on or pinched by items placed upon or against them, paying particular attention to cords at plugs, convenience receptacles, and the point where they exit from the product.

14) Outdoor Antenna Grounding — If an outside antenna or cable system is connected to the product, be sure the antenna or cable system is grounded so as to provide some protection against voltage surges and built-up static charges. Article 810 of the National Electrical Code, ANSI/NFPA 70, provides information with regard to proper grounding of the mast and supporting structure, grounding of the lead-in wire to an antenna discharge unit, size of grounding conductors, location of antenna-discharge unit, connection to grounding electrodes, and requirements for the grounding electrode.

"Note to CATV system installer:

This reminder is provided to call the CATV system installer's attention to Section 820-40 of the NEC which provides guidelines for proper grounding and, in particular, specifies that the cable ground shall be connected to the grounding system of the building, as close to the point of cable entry as practical.

Example of Antenna Grounding as per National Electrical Code, ANSI/NFPA 70

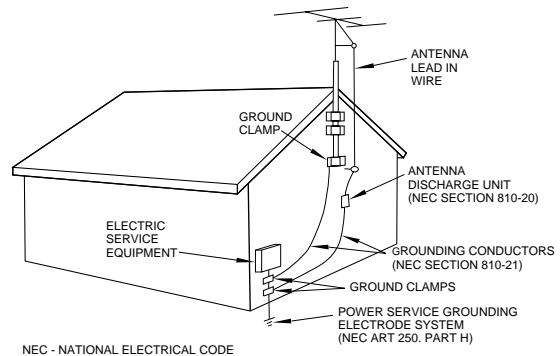

15) Lightning — For added protection for this product during a lightning storm, or when it is left unattended and unused for long periods of time, unplug it from the wall outlet and disconnect the antenna or cable system. This will prevent damage to the product due to lightning and power-line surges.

16) Power Lines — An outside antenna system should not be located in the vicinity of overhead power lines or other electric light or power circuits, or where it can fall into such power lines or circuits. When installing an outside antenna system, extreme care should be taken to keep from touching such power lines or circuits as contact with them might be fatal.

17) Overloading — Do not overload wall outlets, extension cords, or integral convenience receptacles as this can result in risk of fire or electric shock.

18) Object and Liquid Entry — Never push objects of any kind into this product through openings as they may touch dangerous voltage points or short-out parts that could result in a fire or electric shock. Never spill liquid of any kind on the product.

19) Servicing — Do not attempt to service this product yourself as opening or removing covers may expose you to dangerous voltage or other hazards. Refer all servicing to qualified service personnel.

20) Damage Requiring Service — Unplug this product from the wall outlet and refer servicing to qualified service personnel under the following conditions:

- a) when the power-supply cord or plug is damaged.
- b) if liquid has been spilled, or objects have fallen into the product.
- c) if the product has been exposed to rain or water.
- d) if the product does not operate normally by following the operating instructions. Adjust only those controls that are covered by the operating instructions as an improper adjustment of other controls may result in damage and will often require extensive work by a qualified technician to restore the product to its normal operation.
- e) if the product has been dropped or damaged in any way.
- f) when the product exhibits a distinct change in performance — this indicates a need for service.

21) Replacement Parts — When replacement parts are required, be sure the service technician has used replacement parts specified by the manufacturer or have the same characteristics as the original part. Unauthorized substitutions may result in fire, electric shock, or other hazards.

22) Safety Check — Upon completion of any service or repairs to this product, ask the service technician to perform safety checks to determine that the product is in proper operating condition.

23) Wall or Ceiling Mounting — The product should be mounted to a wall or ceiling only as recommended by the manufacturer.

24) Heat — The product should be situated away from heat sources such as radiators, heat registers, stoves, or other products (including amplifiers) that produce heat.

Table of Contents

1 - Introduction to the DA-40	
1.1 Features.....	6
1.2 Unpacking and inspection	6
1.3 Installation of the tape deck	6
1.4 About DAT cassettes.....	6
1.4.1 Head cleaning.....	7
1.5 Making connections	7
1.5.1 Making analog connections.....	7
1.5.2 Digital formats.....	7
1.5.3 Making digital audio connections ...	7
1.5.4 Making control connections	7
1.5.5 Power connections	8
1.6 Block Diagram.....	8
1.6 Front and Rear panels	
2 - Parts of the tape deck	
2.1 Power and display	10
[1] POWER switch.....	10
[2] Cassette tray and OPEN/CLOSE button	10
[3] Display window.....	10
2.2 Recording mode and source switches, etc.....	10
[4] RECORD MODE switch	10
[5] Fs switch	11
[6] INPUT selector switch.....	11
[7] DIGITAL INPUT selector switch	11
[8] ANALOG INPUT selector switch	11
[9] INPUT level controls.....	11
[10] PHONES control and jack.....	11
2.3 Tape controls	11
[11] SKIP keys	11
[12] REW and F FWD keys	12
[13] STOP key.....	12
[14] PLAY key	12
[15] PAUSE key	12
[16] RECORD key	12
[17] REC MUTE key.....	13
[18] SHUTTLE wheel	13
[19] DATA dial	13
2.4 Command keys	14
[20] COUNTER MODE	14
[21] CHAR	14
[22] MARGIN RESET	14
[23] DISPLAY	14
[24] SKIP PLAY.....	15
[25] AUTO ID.....	15
[26] ENTER	15
[27] MENU	15
[28] LOC 1	15
[29] LOC 2.....	15
[30] SINGLE PLAY.....	15
[31] SHIFT	16
2.5 Rear panel	16
[32] DIGITAL (AES/EBU) INPUT/OUTPUT	16
[33] DIGITAL (COAXIAL) INPUT/OUTPUT	16
[34] CONTROL I/O	16
[35] REMOTE IN.....	16
[36] Power cord.....	16
[37] (BALANCED) ANALOG INPUTS.....	16
[38] (UNBALANCED) ANALOG INPUTS....	16
[39] (UNBALANCED) ANALOG OUTPUTS	16
[40] (BALANCED) ANALOG OUTPUTS.....	17
3 - Menu functions	
3.1 Drum time (head time)	18
3.2 Auto ID level	18
3.3 Auto ID time	18
3.4 Record mute time.....	19
3.5 Digital output format.....	19
3.6 Copy prohibit.....	19
3.7 End ID.....	19
3.8 Repeat mode.....	19
3.9 Pre-roll time	19
3.10 End tally signal.....	20
3.11 Auto rewind	20
3.12 Fast forward mode	20
3.13 Parameter save.....	20
3.14 Initializing settings.....	20
3.15 Viewing points at which block errors have occurred.....	20
4 - SHIFT functions	
4.1 REPEAT.....	22
4.2 CHECK	22
4.3 INS/+ and DEL/-	22
4.4 ID markers (START, SKIP, END, CHAR and renumbering).....	22
4.4.1 Selecting an ID mode	23
4.4.2 Manually writing a START or SKIP ID (i)	23
4.4.3 Writing a START or SKIP ID (ii)	23
4.4.4 Writing an END ID.....	24
4.4.5 Erasing a START or SKIP ID.....	24
4.4.6 Erasing an END ID	24
4.4.7 Erasing titles	24
4.4.8 Renumbering START IDs.....	24
4.5 The EDIT key.....	25
4.6 Location memories	25
4.6.1 Locating to location memories.....	25
4.6.2 Setting location memories.....	25
4.6.3 Editing location memories.....	25
4.7 Program mode.....	26
4.8 Character editing (titling)	26
4.8.1 Entering and editing titles.....	26
4.8.2 Writing the title to tape.....	27
4.8.3 Checking a title	27
4.8.4 Deleting a title	27
4.8.5 Copying and pasting a title.....	27
5 - RC-D45 remote control unit (option)	
[41] OPEN/CLOSE.....	28
[42] CAPS	28
[43] CHECK.....	28
[44] POSITION	28
[45] ID SELECT.....	28

[46] AUTO ID.....	28	[62] SAMPLING MONITOR key	29
[47] INS/+ and DEL/-.....	28	[63] REW and F FWD	29
[48] EDIT	28	[64] LOC 1 and LOC 2 keys.....	29
[49] ENTER	28	[65] REC MUTE	29
[50] MENU	28	[66] STOP	29
[51] Numeric keys	28	[67] PLAY.....	29
[52] Cursor keys.....	28	[68] PAUSE.....	29
[53] COUNTER MODE	28	[69] RECORD keys.....	29
[54] MARGIN RESET	28	6 - Specifications	
[55] CHAR	28	6.1 Audio specifications	30
[56] DISPLAY	29	6.2 I/O specifications.....	30
[57] SKIP PLAY.....	29	6.3 Physical specifications	30
[58] SINGLE PLAY.....	29	6.4 Dimensional drawing	31
[59] REPEAT	29	6.5 Error messages	31
5.1 Remote control transport keys	29	6.5.1 Warning messages.....	31
[60] SKIP keys	29	6.5.2 Serious error messages.....	31
[61] MEMO 1 and MEMO 2 keys.....	29		

1 - Introduction to the DA-40

The DA-40 Digital Audio Tape (DAT) deck is referred to throughout this manual as “the tape deck”.

Please make a note of the different sections of this manual to assist you in locating the function you need. The index should also be of use in helping you to find the correct section of the manual.

1.1 Features

The tape deck provides the following features:

- Superior quality digital-to-analog and analog-to-digital conversion for maximum sonic fidelity
- Extended long-play option, allowing twice the standard recording time.
- AES/EBU and SPDIF digital audio input and output formats for full flexibility
- Balanced (+4 dBu) and unbalanced (-10 dBV) analog inputs and outputs
- Comprehensive display options, showing elapsed time, time remaining on the tape, etc.
- Character entry and editing, allowing tape and program titles to be displayed as the tape is played
- Optional wired remote control unit (RC-D45) for control of all major functions
- Shuttle facilities, allowing precise positioning of the tape using audio cues
- Location to frame accuracy to location memories
- Comprehensive menu options, allowing many everyday function settings to be set up and memorized

1.2 Unpacking and inspection

When you first receive the tape deck, be careful not to damage it while unpacking it. Save the carton and packing materials in case it must be transported later.

In addition to the tape deck itself, the carton should contain a rack mount screw kit .

If any items are missing or appear to have been damaged in transit, contact your TASCAM dealer at once.

1.3 Installation of the tape deck

The tape deck may be installed in most studio-type environments, but to maintain optimum performance and to maximize the life of the tape deck, the environment should meet the following specifications:

- the ambient temperature should be between 5° C and 35° C (41° F to 95° F)
- the relative humidity should be between 30% and 60% (non-condensing)
- the tape deck should not be located near any strong magnetic fields (TV sets or monitors, speakers, etc.)

The tape deck may be mounted in a standard 19 inch EIA rack using the supplied rack mounting screws. Make sure that the rack is strong enough to take the weight of the tape deck (over 8 kg— 17 lbs.).

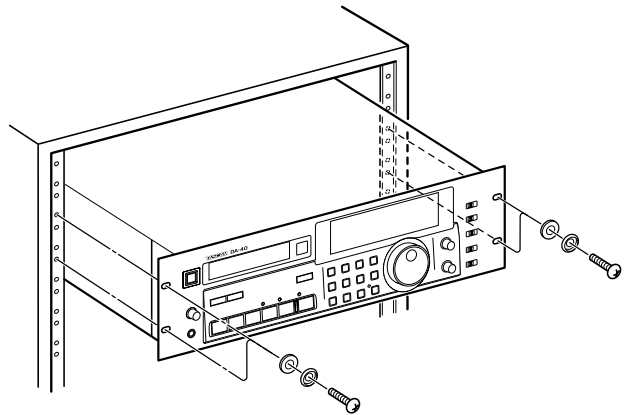

WARNING

If the tape deck is mounted in a mobile installation, and it is moved from a cold location to a warm one, leave the tape deck turned on with no tape inserted to allow the internal temperature to stabilize before the tape deck is used again (about one or two hours). This will prevent any possible damage to the heads, and other parts of the internal mechanism.

1.4 About DAT cassettes

If you have not used a DAT recorder before, here are a few items of information about DAT cassettes and their use with the tape deck which you may find useful:

The cassette shell of a DAT cassette is designed to prevent the tape from being touched by hand. Never try to open the tape protection lid and touch the tape. Fingerprints on the tape may cause wear and damage to the tape deck heads.

DAT cassettes can only be loaded and unloaded when the tape deck is switched on. Do not leave cassettes in the deck when the deck is switched off.

Always store DAT cassettes in their plastic cases to prevent dust damage. Keep them away from magnetic fields (TV sets and monitors, speakers, etc.)

Although 180-minute DAT cassettes are available, we do not recommend their use, as the tape in these cassettes is thin, and may cause winding problems, and physical damage to the tape.

DAT cassettes play in one direction only. Always load DAT cassettes with the tape window uppermost, and the arrow on top of the cassette pointing into the tape deck, as illustrated below:

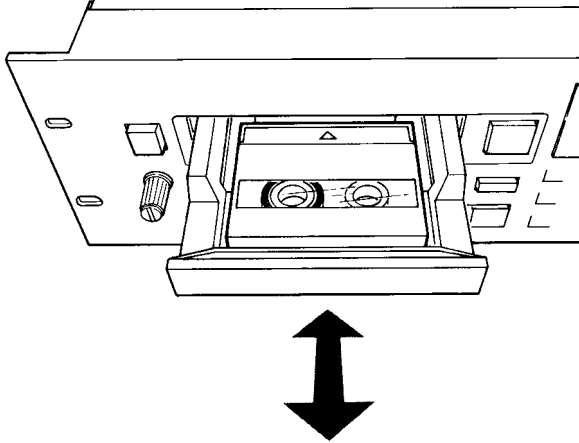

NOTE

Start recording on a new blank tape from the beginning of the tape. There is no need for a lead-in section, and recording from the start of the tape will record the subcode from the start, allowing accurate positioning within the tape.

Also note that DAT cassettes are fitted with a sliding write-protect tab to prevent accidental recording. The cassette is write-protected when the tab is closed.

1.4.1 Head cleaning

Never attempt to clean the head of a DAT deck in the same way that you clean the head of an analog tape deck. Always use a special DAT head cleaning cassette. Follow the instructions on the cleaning cassette for optimum performance.

The head may need to be cleaned if you hear errors (noise) on playback or while recording. You can make a visual check of the error rates and error locations using the **DISPLAY [23]** key or the error display menu (3.15, "Viewing points at which block errors have occurred").

1.5 Making connections

NOTE

Before making any audio connections to the tape deck, make sure that all equipment is turned off.

1.5.1 Making analog connections

Use balanced cables to make connections between the **BALANCED INPUT** (female) and **OUTPUT** (male) XLR connectors of the tape deck, and the outputs and inputs of other audio equipment operating at the professional +4 dBu level. The wiring standards for the XLR connections are printed on the rear panel of the tape deck (1 = ground, 2 = hot, 3 = cold)

Use unbalanced cables to make connections between the unbalanced input and output RCA connectors of the tape deck and the outputs and inputs of audio equipment operating at other levels.

1.5.2 Digital formats

Previously, the professional and consumer digital audio formats were referred to as "AES/EBU" and "SPDIF". In this manual, they are referred to by their official names as "AES/EBU3-1992" and "IEC60958" formats respectively. Please note that there is no change to the data format--this is a name change only.

1.5.3 Making digital audio connections

Use cables wired in accordance with the AES/EBU standard to connect the **DIGITAL (AES/EBU) INPUT** (male) and **OUTPUT** (female) XLR connectors of the tape deck to other digital audio equipment.

Use unbalanced cables to connect the **DIGITAL (COAXIAL) INPUT** and **OUTPUT** RCA connectors of the tape deck to other digital audio equipment.

NOTE

The use of analog cables is not recommended for digital audio use, and TASCAM cannot guarantee reliable performance if such cables are used for digital audio connections.

1.5.4 Making control connections

The optional RC-D45 remote control unit may be connected to the **REMOTE IN** jack, using the 5 m (approximately 16 ft) cable of the RC-D45.

WARNING

Do not attempt to use the tape deck with any remote control unit except one designed especially for use with this tape deck.

The **CONTROL I/O** connector is for use with suitably-equipped control units (see **CONTROL I/O [34]**).

1.5.5 Power connections

Make sure that your AC voltage supply matches the voltage requirements of the tape deck (as printed on the rear panel).

1.6 Block Diagram

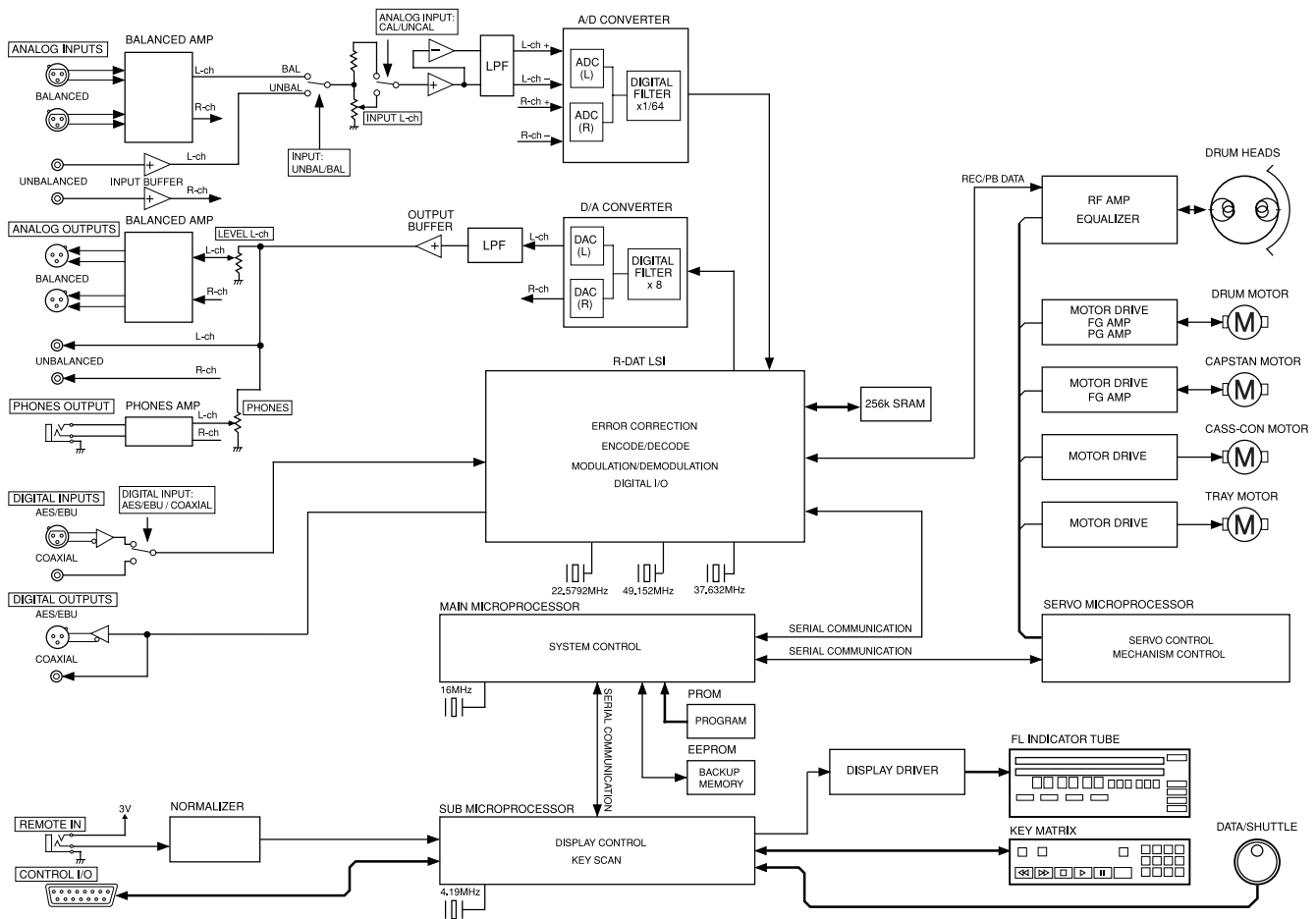

Front and Rear panels

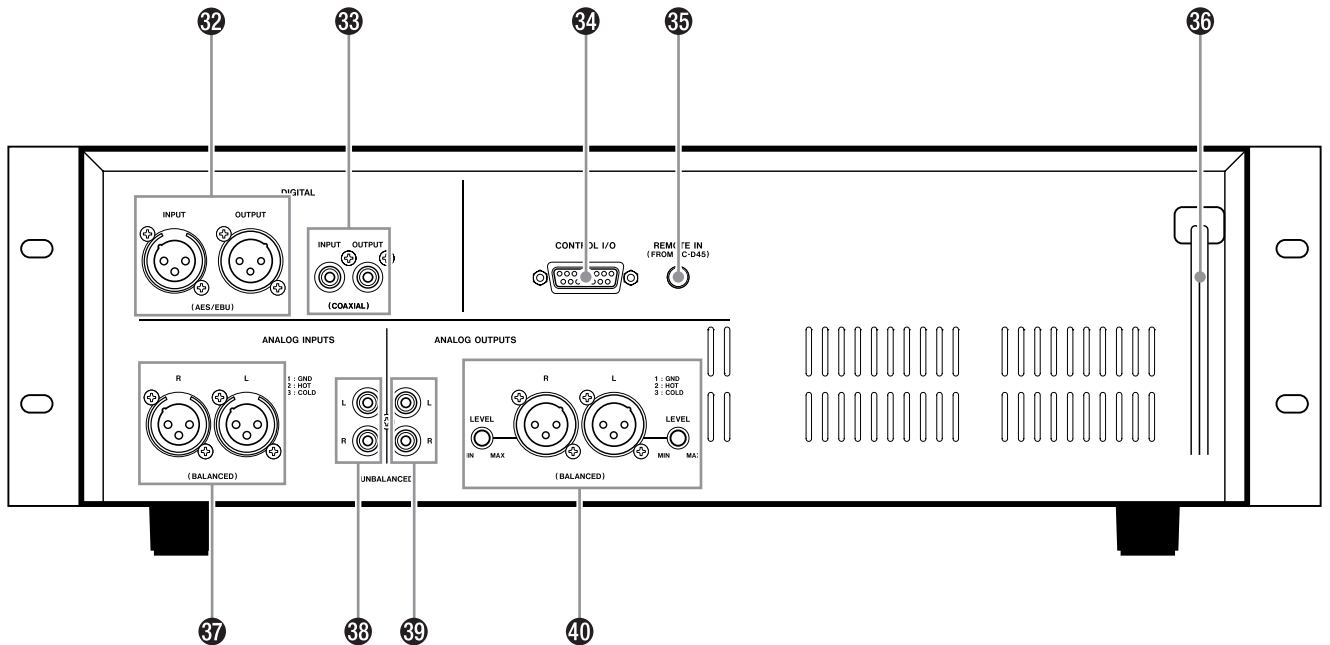
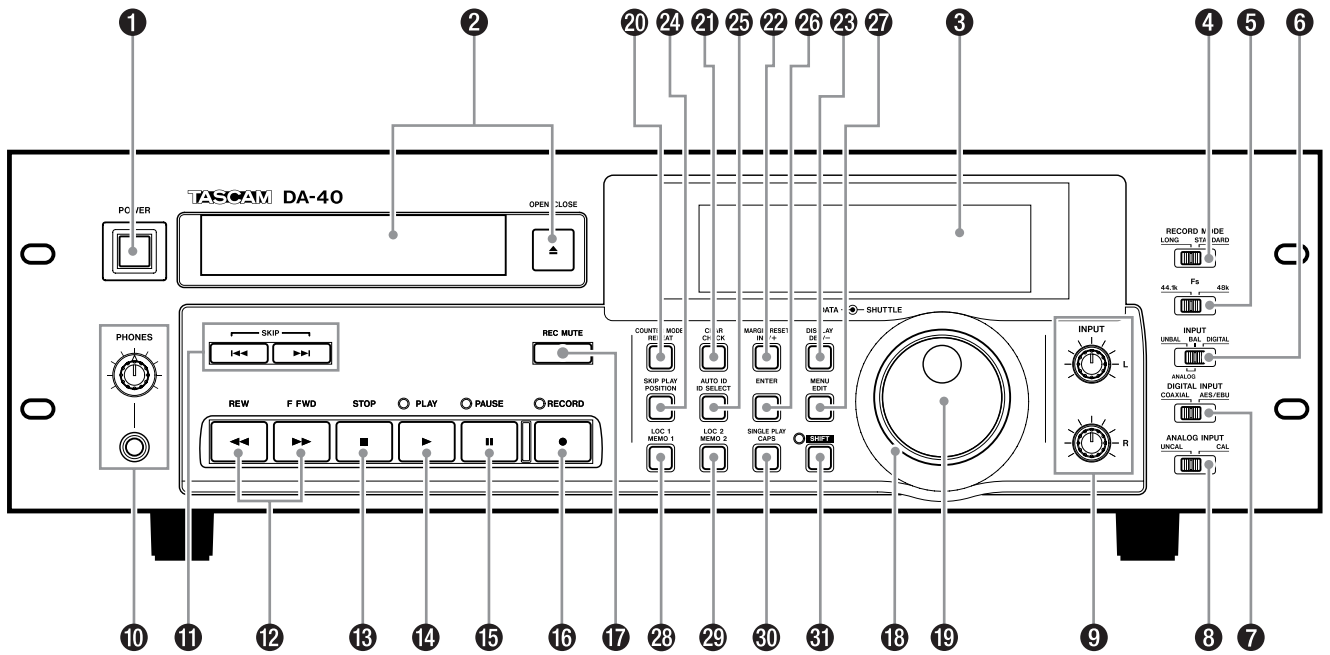

2 - Parts of the tape deck

NOTES

As well as providing details of the settings made with switches, etc., this section also provides the information necessary for basic operations of the tape deck. Although the operation of the transport keys, etc. will be familiar, there are some additional features of this tape deck, and the operation of these features may differ slightly from the way in which they are implemented on other units. Please consult 2.3, "Tape controls" for full details of such features and their operation.

The operation of the optional RC-D45 remote control unit is explained in 5, "RC-D45 remote control unit (option)".

The more commonly-used functions of the function keys (below the display) which are labeled in white above the keys are also described in this section. The less commonly-used functions, labeled in blue above the keys, are described in 4, "SHIFT functions".

2.1 Power and display

[1] POWER switch

Push once to turn the power on, and again to turn the power off.

[2] Cassette tray and OPEN/CLOSE button

Always load DAT cassettes in the way illustrated on page 7.

Press the open/close button to open the tray. If a cassette is already loaded, it will be unthreaded, and the words `Tray Open!` will flash on the display. After the tray is fully open, these words will be shown (not flashing).

When the tray is open, and the open/close button is pressed, the words `Tray Close` will flash on the display. If a tape is correctly inserted in the tray when it is closed, the display will show a counter value.

[3] Display window

The different modes available for display are described more fully below (**COUNTER MODE** [20] and **DISPLAY** [23]).

Above the tape counter in the display are two bar-graph peak level meters which show either the level of the input signals, or the level of the signals recorded on tape, depending on the current status of the transport.

Other indicators in the display provide information on the current status of the tape deck and of the tape (e.g. sampling frequency, repeat status, and the various IDs encountered when a tape is being replayed).

NOTE

In this manual, we use the term "program" to describe part of a recording between two START IDs. This is equivalent to the term "track" on a CD or MD. Since the term "track" is already established with another meaning in analog tape recording technology, the term "program" is used here instead.

2.2 Recording mode and source switches, etc.

The following controls affect the recording mode, and the selection of the signal source when making recordings.

[4] RECORD MODE switch

Use the switch to select between **LP** (long play) and **SP** (standard play). In standard play mode, the sampling frequency is as selected with the **FS** switch below. In long play mode, the sampling frequency is fixed at 32 kHz. In the long play mode, the tape speed is halved, meaning that a tape labeled as a 90-minute tape will therefore provide 180 minutes of recording time.

NOTES

If you are using a tape that has already been recorded in one mode, and you are making a recording using another mode, we suggest that you record the whole tape in the new mode, with no input signal, before making the audio recording.

Recording in long play mode is only possible from analog sources, or if the digital source has already been recorded at 32 kHz.

No setting is necessary to select the mode for playback—the tape deck recognizes the mode in which the tape was recorded, and adjusts itself accordingly.

[5] Fs switch

Use this switch to select the sampling frequency (44.1 or 48 kHz) when making analog recordings. When making digital recordings, the sampling frequency is automatically detected.

When playing back tapes that have already been recorded, this switch has no effect. The sampling frequency of a recorded tape is fixed, and cannot be changed.

NOTE

When making long play recordings, settings made with this switch have no effect. The sampling frequency is fixed at 32 kHz.

[6] INPUT selector switch

The left (**UNBAL**) and center (**BAL**) positions of this switch allow the selection between the unbalanced RCA jacks or the balanced XLR jacks respectively.

The right (**DIGITAL**) position allows the selection of the digital input jacks.

[7] DIGITAL INPUT selector switch

When the **INPUT** switch [6] is set to the **DIGITAL** position, this switch is used to choose between the RCA **COAXIAL** and the XLR **AES/EBU** digital audio input sources.

NOTE

*Despite the name of the switch setting and the connectors (**AES/EBU**), the XLR connectors are capable of receiving SPDIF format input, and the RCA **COAXIAL** connectors are capable of receiving AES/EBU format. The tape deck will automatically detect the input format and adjust itself accordingly.*

[8] ANALOG INPUT selector switch

When the **INPUT** switch [6] is set to **ANALOG**, this switch is used to select between **UNCAL** and **CAL**.

UNCAL means that the analog signal source works at an uncalibrated nominal level which is neither +4 dBu nor -10 dV, requiring the use of the input level controls to adjust the recording level.

The **CAL** position is for use with analog sources which are calibrated to use either the standard

+4 dBu or the -10 dBV level as a nominal level. The input level controls are not used in this case.

NOTE

*If this switch is set to the **CAL** position, make sure that no parts of the program material will cause clipping.*

[9] INPUT level controls

When recording from analog sources with the **ANALOG INPUT** switch [8] set to **UNCAL**, these controls adjust the level of the input signal to the left and right tape tracks.

They have no effect when the switch is set to the **CAL** position, or when recording from a digital audio source.

[10] PHONES control and jack

Any standard pair of stereo headphones may be plugged into this 1/4-inch jack, and the level adjusted with the rotary control.

2.3 Tape controls

The following keys provide control of the tape transport, recording modes, etc. Please read this section carefully if you are not sure of transport operations using the tape deck.

[11] SKIP keys

These keys are used to move the tape forward or backward by a certain number of programs.

NOTE

A "program" on a DAT cassette starts with a START ID marker. The audio portion of the data recorded on a DAT cassette is not used to determine the division into tracks.

Repeated presses of these keys will move the tape forwards or backwards by the appropriate number of programs (pressing the skip forward key once will move the tape to the beginning of the next program, etc.).

While the tape is locating, the display will show (flashing on the right) the number of programs which must still be passed, and (on the left) the current program number:

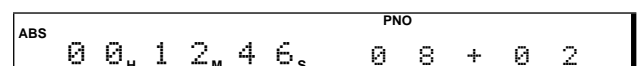

2 - Parts of the tape deck

In the above example, the tape is currently on program 8, and must move two programs forward before the correct program (i.e. program 10) is reached.

The flashing number on the right of the display should be used as the definitive indication of how many programs will be skipped (if the **SKIP** keys are pressed too quickly, it is possible that some of the key presses will not be recognized).

When the start of the desired program is reached, the tape deck will enter the play mode if the tape was playing before the skip operation, otherwise it will enter pause mode.

[12]REW and F FWD keys

Use these keys to wind backwards or forwards fast through the tape.

If the tape is stopped or paused, and one of these keys is pressed, << or >> will be shown on the right of the display to indicate the direction of the tape movement, if the margin is being displayed (see **DISPLAY [23]**).

If normal mode has been selected (3.12, "Fast forward mode"), pressing either of these keys when the tape is playing will start fast forward or rewind.

If the tape is playing when one of these keys is pressed, and cue mode has been selected (3.12, "Fast forward mode"), the tape enters a "cue" or "review" mode, in which the tape is played forward or backward at twice or four times normal speed. The cue/review speed can be changed by pressing the **REW** or **F FWD** key again, and is shown on the display as >>2/>>4 (cue), <<2/<<4 (review).

[13]STOP key

Use this key to stop the transport from whatever mode is currently selected. This includes the "input monitor" mode (see **[16]** below).

[14]PLAY key

Use this key to start playing when the tape is stopped or paused, or to start recording when the tape is in record pause mode (see below).

The indicator above the key will light when the tape is playing back. In this case, the indicator will be the only transport indicator lit.

The indicator may also be lit in combination with the **PAUSE** indicator, showing that the unit will enter playback mode almost instantly when the **PLAY** key is pressed.

If the **REC** indicator is lit together with the **PLAY** indicator, the unit is recording.

If the tape is locating as the result of a command to search for the beginning of a program (skip or program play), and the unit was in play mode before this search operation started, the **PLAY** indicator will flash, showing that the unit is in "auto play" mode, and playback will restart when the location is reached.

[15]PAUSE key

Use this key to put the tape deck into pause mode, as explained below.

If the tape is stopped or playing, pressing the **PAUSE** key will put the tape deck into paused play mode (the **PLAY** and **PAUSE** indicators will both light).

If the tape deck is in "input monitor" mode (see **[16]** below), pressing and holding down the **RECORD** key and pressing the **PAUSE** key will put the tape deck into record ready mode (the **PAUSE** and **RECORD** indicators will both light).

From the record ready mode, pressing the **PLAY** key will start recording (the **PLAY** and **RECORD** indicators will both light).

If the tape deck is left in pause mode for some time (three minutes or so), it will drop back into stop mode.

[16]RECORD key

Use this key for recording, as described here.

Press this key once to enter the "input monitor" mode. In this mode, the display gives information about the current status of the tape deck and the connections, ensuring that clock signals, digital audio connections, etc. are properly made before recording starts.

If all clock connections are in order, the display will show **ANALOG in, AES/EBU** or **COAXIAL**. The peak level meters will show the signal levels received through the selected inputs.

In the case of the latter two digital options, the sampling frequency (either **32**, **44** or **48**) will be shown. If a digital input source is selected, and the sampling frequency of the received signal is outside the allowable range ($\pm 0.1\%$) the display will show the signal source (**AES/EBU** or **COAXIAL**), followed by a question mark. Input monitoring is possible, but recording is not possible.

If the selected digital input is interrupted or is incorrect for any reason, the words **DIGITAL IN**, shown on the bottom right of the display will blink to alert you of the fact.

From the input monitor mode, pressing and holding the **RECORD** key and pressing the **PLAY** key will start recording (the **RECORD** and **PLAY** indicators will both light).

From the input monitor mode, pressing and holding the **RECORD** key and pressing the **PAUSE** key will put the tape deck into record ready mode (the **RECORD** and **PAUSE** indicators will both light).

NOTES

If the tape deck is left in record ready mode for three minutes or longer, it will automatically enter the input monitor mode (the head drum will stop spinning).

It is possible to enter input monitor mode with a write-protected cassette inserted, or with no cassette inserted.

*It is also possible to enter the record mode directly from the stop mode by pressing and holding the **RECORD** key and pressing the **PLAY** key. It is also possible to enter the record ready mode directly from the stop mode (**RECORD** key and **PAUSE** key).*

When the tape deck is in record ready mode, when recording on a tape which has previously been recorded or “formatted” by recording silence, turning the **DATA** dial [19] allows the selection of a program number other than 01, meaning that this recording will start at the selected number, and subsequent programs will be written with numbers automatically incremented from this selected value.

NOTE

Valid program numbers are from 01 to 99. If the above procedure is used to select a program number at the high end of the range, and the automatic increment procedure takes the number above 99, the number will “wrap” to 00. The number 00 can cause problems when searching and locating, and this should be remembered when setting program numbers.

[17] REC MUTE key

Use this key to record a period of silence on the tape. If the tape deck is recording, and this key is pressed, the **RECORD** indicator will flash, and all input to the tape will be muted. After a number of seconds (defined in the menu **RecMut** function—see 3.4, “Record mute time”), the tape deck will enter the record ready mode (the record and pause indicators will both be lit).

Pressing and holding the key for a few seconds will mute the input, and will put the tape deck into record ready mode as soon as the key is released.

[18] SHUTTLE wheel

Turn this wheel to move the tape backwards (counterclockwise) or forwards (clockwise). Turning the wheel further from the center will make the tape move faster in the appropriate direction.

The tape may be shuttled both forwards and backwards, from normal speed to twelve times normal speed.

When entering characters for program titles, and editing memory locations, etc., this control acts as a cursor control (counterclockwise to move the cursor to the left, and clockwise to move it to the right).

[19] DATA dial

This dial is used for two major functions.

One is to change the value of data in menus and parameter settings.

It can also be used, however, to select an absolute program number at which playback should start (compare this with the **SKIP** keys, which are used to select a program number relative to the current number).

While the tape is stopped or paused, and a menu or edit function is not displayed, turn the data dial.

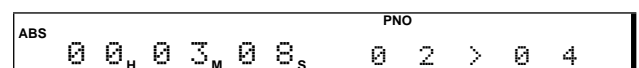

The program number following the > sign flashes. Program numbers can be from 01 through 99, and turning the **DATA** dial past the limit will start at the other end of the list.

Press the **PLAY** key within five seconds of turning the **DATA** dial to locate to the start of the program and start playing.

Press the **PAUSE** key within five seconds of turning the **DATA** dial to locate to the start of the program and put the tape deck into pause mode.

2 - Parts of the tape deck

NOTE

If the **DATA** dial is turned by mistake, either leave the tape deck alone for five seconds to cancel the operation, or press the **STOP** key.

2.4 Command keys

These command keys have two modes: the primary mode, labeled in white above the key, is the most common use for the key. The secondary, or shifted, mode is labeled in blue above the key, and is only operative when the **SHIFT** indicator [31] is lit (see 4, "SHIFT functions" for details of these secondary modes).

[20] COUNTER MODE

Use this key to cycle through the different tape counter modes available:

- **ABS** time— the absolute time as recorded on the subcode of the tape. This is expressed in hours, minutes and seconds. If the tape is at an unrecorded location, the tape counter will show all dashes.

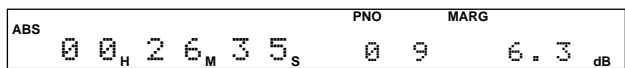

- **PGM** time— the elapsed time since the last START ID which has been read from tape (the beginning of the program). If, when the display is in this mode, the tape is located to a point outside a START ID and playback restarts, the tape deck will be unable to determine the time since the start of the program and the display will show all dashes instead of a time value.

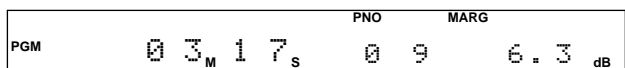

- **REMAIN** time— the time remaining on the currently-loaded cassette; to minute accuracy. Cassettes from different manufacturers may vary slightly in length, resulting in different values being shown for tapes which are nominally the same length.



NOTE

In LP mode, the counter shows one second of tape time for every second of real time in the ABS, PGM and REMAIN counter modes. For example, after one hour's playback or recording in LP mode, the counter will only show 30

minutes. Bear this in mind when you are using the LP mode.

- **Tape Counter mode**— no indication is given on the display of the mode, and a 4-digit number is used to show the tape position. This value is relative to a user-definable reference "zero" point (see **MARGIN RESET** [22]).

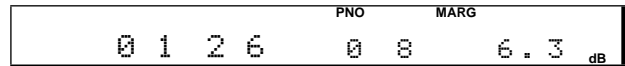

[21] CHAR

If characters have been recorded on the tape as a tape or program title, pressing this key will allow the tape deck to display these characters, scrolling across the display, as the START ID containing the title is played back. They will be replaced by successive title contents as they are read from tape. If characters are read from a START ID, the **CHAR** indicator will light in the display to indicate this. If no characters have been recorded on the tape, pressing this key will have no effect.

[22] MARGIN RESET

Pressing this key resets the margin (available head-room) to its lowest level of 40dB. Note that in some display modes, there is no visible effect when this key is pressed.

The margin is measured in 1 dB increments between 40 dB and 20 dB and in 0.1 dB increments between 19.9 dB and 0 dB.

If the time display is in the 4-digit tape counter mode, pressing this key will reset the tape counter.

[23] DISPLAY

Regardless of the current counter mode set by [20], this key is used to display other information. The options available, which are accessed by repeated presses of this key, are:

- **Program number and Margin** mode— where the current program number and margin in decibels are displayed:

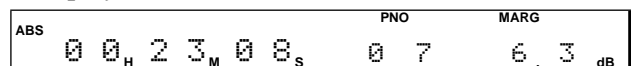

- **Frames** mode— where frames are displayed as well as hours, minutes, and seconds. The frames used are "digital audio" frames, i.e. there are 100 frames in every three seconds; 33 in the first second, 33 in the next, and 34 in the third. The pattern then repeats itself.

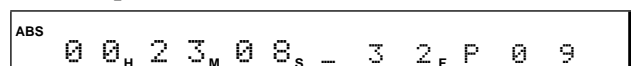

- **Block Error Rate** mode— the last digits of the display show E - - - - when out of play mode. When playback starts, the error rate for either the A or B track is displayed. The A or B track is selected using the **MENU** key while the error rate display mode is active.

```
ABS 00h 23m 08s A 0 0 1 7
```

- If titles have been recorded on the tape (see 4.8, "Character editing (titling)"), **CHAR** is shown on the display, and the characters comprising the title are shown on the display (here, the word "TAS-CAM" is used as the title):

```
ABS 00h 23m 08s T A S C A M
```

[24] SKIP PLAY

When skip mode is active, **SKIP PLAY** is shown on the display. Skip mode means that when a SKIP ID is encountered on tape, the tape will fast forward until the next START ID is encountered.

[25] AUTO ID

When AUTO ID mode is active, **AUTO ID** is shown on the display (see 4.4, "ID markers (START, SKIP, END, CHAR and renumbering)" if you are unsure about ID marker types). This means that when recording, a START ID will automatically be written when a "trigger level" signal is detected after a period of silence.

The number of the new START ID is one greater than the last ID successfully read from tape. However, the automatic numbering of IDs will be out of sequence if a START ID is added between existing IDs, or if an ID is written before a valid previously-recorded START ID has been read from tape. Use the renumber function to restore the sequence. See 4.4, "ID markers (START, SKIP, END, CHAR and renumbering)".

The level which will trigger the automatic writing of a START ID, and the length of the silence to precede it may be set from the menu items (see 3.2, "Auto ID level" and 3.3, "Auto ID time").

When you use the AUTO ID key to turn on the auto ID mode, these values (the level and time) will be shown for one second on the display. For example, the display may show AT-ID 48/2.0, meaning that the trigger level is set to -48 dB and the length of the preceding silence is set to 2.0 seconds.

[26] ENTER

This key is used to confirm entries made in the menu and EDIT settings.

It is also used, when in EDIT mode (see 4, "SHIFT functions"), to enter the EDIT functions).

When recording subcode (START, SKIP, END IDs and CHAR title information), it is used to start the writing of this information to tape.

[27] MENU

Repeated presses of this key (when the display is not in Block Error mode) cycle through the different options available in the menu. These options are explained in detail in 3, "Menu functions".

[28] LOC 1

Pressing this key will locate the tape to the first memory location (set with this key in shifted mode). If the tape is playing when this key is pressed, the tape will resume playing when the location is reached, otherwise it will stop.

When the key is pressed, the value stored in the first location memory will flash on the right side of the display (frames, program numbers and margin will disappear while the tape is locating, and be restored once location is complete).

If a pre-roll time has been set in the menu, pressing this key will locate to the memory location minus the pre-roll time.

When search or locate is entered from the tape stopped or in play pause mode, and the **PLAY** key is pressed while the search or locate operation is taking place, deferred playback will occur when the location point is reached. However, if the **PLAY** key is pressed when the tape is close to its final operation, you should note that there may be a problem with the deferred playback.

[29] LOC 2

This key functions in exactly the same way as **LOC 1** [28] above, except that the second location memory is used rather than the first.

[30] SINGLE PLAY

The single play mode, when active, will play only one program, i.e. when the next START ID is encountered, playback will stop. When single play mode is active, the display will show **SINGLE PLAY**.

2 - Parts of the tape deck

[31] SHIFT

This key is a latching key. When active, the indicator beside and above the key lights, and the command keys take on their shifted functions, as indicated by the blue captions above them.

See 4, "SHIFT functions" for details of these shifted functions.

2.5 Rear panel

[32] DIGITAL (AES/EBU) INPUT/OUTPUT

These XLR-type connectors conform to the AES/EBU3-1992 standard and are used to accept (**INPUT**) and transmit (**OUTPUT**) digital audio data in that format. The **INPUT** connector can also receive balanced IEC60958 format (SPDIF) data. The format of data received (AES/EBU or SPDIF) is automatically detected.

[33] DIGITAL (COAXIAL) INPUT/OUTPUT

These RCA connectors conform to the IEC60958 standard (SPDIF), and are used to accept (**INPUT**) and transmit (**OUTPUT**) digital audio data in that standard. The **INPUT** connector can also receive unbalanced AES/EBU3-1992 format data. The format of data received (AES/EBU or SPDIF) is automatically detected.

[34] CONTROL I/O

This 15-pin 'D'-sub connector is used for connection to a suitably-equipped controller.

As well as the mode described in the table below, this connector can also be used as a serial connector. Please contact your TASCAM distributor for details of this facility.

The pinouts of this connector are given below:

Pin number	Signal	Direction	Function
1	STOP	IN	External command reception; active when low (at ground potential for 30 ms or more)
2	FWD PLAY	IN	
3	F.FWD	IN	
4	REW	IN	
5	PAUSE	IN	
6	REC PLAY	IN	
7	SERIAL	IN	

Pin number	Signal	Direction	Function
8	Ground	—	—
9	FWD PLAY TALLY	OUT	Transmit transport status indication signals in open collector (maximum allowable voltage 15 V and maximum allowable current 80 mA)
10	F.FWD TALLY	OUT	
11	REW TALLY	OUT	
12	STOP TALLY	OUT	
13	REC/PLAY TALLY	OUT	
14	PAUSE TALLY	OUT	
15	TAPE END TALLY ^a	OUT	

a. See 3.10, "End tally signal"

[35] REMOTE IN

This 3.5 mm jack is used to connect the optional RC-D45 remote control unit.

Do not use this jack to connect any remote control unit other than one designed especially for use with the tape deck.

[36] Power cord

Make sure that the power supply voltage matches the voltage requirements of the tape deck as marked on the rear panel. If there is any doubt, consult your TASCAM dealer.

[37] (BALANCED) ANALOG INPUTS

These female XLR connectors provide balanced inputs at a nominal +4 dBu level. The wiring of these connectors is: 1 = ground, 2 = hot, 3 = cold. The nominal impedance of these connectors is greater than 25 kΩ.

[38] (UNBALANCED) ANALOG INPUTS

These RCA connectors provide unbalanced inputs at a nominal -10 dBV level. The nominal impedance of these connectors is greater than 50 kΩ.

[39] (UNBALANCED) ANALOG OUTPUTS

These RCA connectors provide unbalanced outputs at a nominal -10 dBV level. The nominal impedance of these connectors is less than 1 kΩ.

[40](BALANCED) ANALOG OUTPUTS

These XLR connectors provide balanced outputs at a nominal +4 dBu level. The nominal impedance of these connectors is less than 10 k Ω .

The trimmer beside each connector can be used to reduce the output level to match the level expected by the equipment connected to the tape deck.

The “standard” setting (and the condition in which the unit is shipped from the factory) is with these trimmers set to maximum (fully clockwise).

3 - Menu functions

The menu facilities on the tape deck allow common settings to be made.

Repeated presses of **MENU [27]** will cycle through the different menu items listed here in the order presented here.

Repeated presses of the **DISPLAY [23]** key when the tape deck is in menu mode will display the different menu items in the opposite order to the one in which they are presented here.

NOTE

*When attempting to access the menus with the **MENU** key, the display mode should not be the Block Error rate display mode. In this display mode, pressing the **MENU** key changes between the A and B tracks.*

When setting values from a menu, turn the **DATA** dial [19] to change the displayed value. The new value will be shown flashing on the display.

Press **ENTER [26]** to confirm the value.

If the **DATA** dial is turned, but no changes are to be made to the displayed value, press the **MENU** key again to return the display to the previous value.

To exit the menu mode, press either the **COUNTER MODE [20]** or the **MARGIN RESET [22]** key.

3.1 Drum time (head time)

```
D r u m - T   0 0 1 0 H
```

Reports the time (in hours) that the head drum has been in use. Use this information to help schedule head cleaning, following the interval between cleanings as recommended by the cleaning cassette.

3.2 Auto ID level

```
A t I D - L   - 4 8 d B
```

When the AUTO ID function is enabled (**AUTO ID [25]**), signals which exceed this level, after a period of relative silence (as set in 3.3, "Auto ID time") will automatically start the recording of a START ID at the point where the signal exceeds this level.

The options available are: -48dB , -54dB , -57dB -60dB and dd . The dd setting detects the digital start of a track.

When the dd setting is made, and if a DAT deck is connected to the tape deck through the **COAXIAL** interface, the START IDs and SKIP IDs on the source deck are transferred over the coaxial connection and recorded on the tape deck.

If a CD player is connected with dd set, when the start of a track is read, a START ID is written on the tape deck.

Note that if an analog connection is made between the tape deck and a CD or DAT recorder, and recording is carried out through the analog connections, if dd has been selected, the Auto ID level is automatically set to -54dB . This is also the case if a digital device other than a DAT recorder or a CD player is attached to the tape deck.

NOTES

CD tracks of less than 18 seconds may not have their corresponding START IDs recorded properly.

In order to ensure accurate program searching, a gap of at least 9 seconds should be left between the end of one START ID and the beginning of the next.

The default value for this menu is -48dB .

3.3 Auto ID time

```
A t I D - T   2 . 0 s e c
```

When the AUTO ID function is enabled (**AUTO ID [25]**), signals which exceed the level set in 3.2, "Auto ID level" will automatically start the recording of a START ID, if the signal has remained below the level for the period set in this parameter immediately before exceeding the trigger level.

Since the tape deck does not read track numbers, etc., from digital audio sources, this function should be used to divide CD tracks and assign new program numbers at the start of each track. Set the "gap time" as appropriate for the program material.

The times available are: 2.0 , 2.5 , 3.0 , 0.5 , 1.0 and 1.5 seconds.

The default value is 2.0 seconds.

3.4 Record mute time

```
R e c M u t     2 s e c
```

Sets the length of the silent period when the **REC MUTE** key [17] is pressed, the input signal to the tape is muted, and a period of silence is recorded.

The values available are: 4, 5, 6, 7, 2 and 3 seconds.

The default value is 4 seconds.

NOTE

The time set here is real time, rather than the time shown on the tape counter, which in LP mode is half that of real time. Accordingly, in LP mode, if the time is set to 4 seconds, this will be the record mute time, even though only 2 seconds show on the tape counter.

3.5 Digital output format

```
F o r m a t     A E S E B U
```

Sets the format of the digital audio data output from both digital audio outputs (the **AES/EBU** XLR connector and the **COAXIAL** RCA connector).

The options available are **AESEBU** (AES/EBU3-1992) format) and **Consmr** (IEC60958 format).

NOTE

Regardless of this setting, in input monitor mode, record pause or record mode, the tape deck will output in the same format as the digital audio signal received at the input.

The default is **AESEBU**.

3.6 Copy prohibit

Sets the level of copy protection for tapes recorded using this tape deck.

```
C o p y I D     F r e e
```

The menu items control the writing of the copy protection bit in the subcode of the recorded material. The options available are: **Free** (no copy protection is applied to the recorded material), **1gen**

(one generation only of digital copying is possible from tapes produced when this setting is made), and **Prohbt** (no digital copying at all is possible). The second option is equivalent to the SCMS system implemented on consumer DAT recorders.

The default value here is **Free**.

3.7 End ID

```
E n d - I D     N o   W R
```

Sets whether an END ID is automatically written whenever recording stops.

The two options available are: **No WR** (no END ID is written when recording stops) and **AutoWR** (an END ID is automatically written when recording stops). When an END ID is written, the display shows **WR-EE**.

When playing back and an END ID is encountered, **EE** is shown on the display, and playback stops. The tape then either stops or rewinds, depending on the setting made in 3.11, "Auto rewind".

The default value is **No WR**.

3.8 Repeat mode

```
R e p e a t     1 0 T M S
```

This menu item controls the number of times that the playback will repeat when the repeat mode is set (see 4.1, "REPEAT").

The options available are: **10TMS** (the playback will repeat 10 times) and **UnLimit** (the playback will repeat indefinitely until stopped).

The default value is **10TMS**.

3.9 Pre-roll time

```
P r e R o l     0 s e c
```

Sets a pre-roll time, so that the tape will locate to a fixed point before either of the location memories when the appropriate key (**LOC 1** [28] or **LOC 2** [29]) is pressed. The setting made here has no effect on locating to the START IDs of programs using the **SKIP** keys [11] or the **DATA** dial [19].

The values available are: 0, 1, 2, 3, 4 and 5 seconds.

3 - Menu functions

NOTE

The time set here is real time, rather than the time shown on the tape counter, which in LP mode is half that of real time. Accordingly, in LP mode, if the time is set to 4 seconds, this will be the pre-roll time, even though only 2 seconds show on the tape counter.

The default value is 0 seconds.

3.10 End tally signal

```
E n d T L Y   T - E n d
```

Controls the timing of the tape end tally signal transmitted through the **CONTROL I/O [34]** port. The signal can either be transmitted at the end of the tape, or at a fixed interval before the tape end.

The values available are: T-End (the tally signal will be transmitted at the end of the tape), 1min, 2min and 3min (the tally signal will be transmitted before the end of the tape is reached).

The default value is T-End.

3.11 Auto rewind

```
A t - R e w   o f f
```

This menu item determines whether the tape will be automatically rewound when the end of the tape or an END ID is reached in play mode.

The two options available are: off (the tape will not be rewound when the end of the tape or an END ID is reached) and on (the tape will be automatically rewound when the end of the tape or an END ID is reached).

The default value is off.

3.12 Fast forward mode

```
F F - K e y   N o r m a l
```

This menu item determines whether the F FWD and REW keys will act as cue and review keys, respectively, if they are pressed while the tape deck is in play mode. The two settings are Normal (the unit will go from play mode to fast wind) and Cue

(the unit will enter cue/review mode when the fast wind keys are pressed).

The setting made here also applies to fast wind commands made through the **CONTROL I/O [34]** connector, and using the optional RC-D45 remote control unit.

The default value is Normal.

3.13 Parameter save

```
P - M o d e   - - - -
```

Saves the following parameters so that they become the default parameters when the tape deck is next powered up:

- Single Play
- Skip Play
- Repeat Mode

When this menu item is first displayed, the right side of the display shows: ----. To save the current settings, turn the **DATA** dial [19], so that the display shows Save, and press **ENTER [26]**.

3.14 Initializing settings

```
* D a t a *   - - - -
```

Resets all menu values to their default settings except for the head time, (see 3.1, "Drum time (head time)", which cannot be reset).

To reset the values to default, turn the **DATA** dial [19] so that the display shows Init., and press **ENTER [26]**.

If the screen shows Init. in error, turn the **DATA** dial again so that the display shows ----.

3.15 Viewing points at which block errors have occurred

```
ABS  00H 23M 08S - 3 2F # 1
```

This display is shown if the **MENU** key is pressed once more following the reset screen above.

This displays up to five points in ABS time format where the block error rate has increased, and error correction is used. Turn the **DATA** dial to view the five points at which these errors have occurred. Turning the dial clockwise after error #5 will show the

total number of such errors (up to a total of 99 errors).

While a block error time is shown on the display, pressing the **LOC 2** key will write the error location to the second location memory and start locating the tape to that point.

While any of the locations or the total number of the tape errors menu is shown on the display, the information can be cleared by pressing the **MARGIN RESET** key. Ejecting the tape will also clear this data.

4 - SHIFT functions

These functions of the tape deck are typically accessed by pressing **SHIFT [31]** so that the indicator is lit.

While the indicator is lit, the command keys take on their shifted function, labeled in blue above the key.

4.1 REPEAT

Repeated presses of the **REPEAT** key [20] cycle through the following:

- A-B repeat— the display shows **REPEAT A-B**— playback is repeated between the two location memory points (A refers to location memory point 1, and B refers to location memory point 2). The points must first be set (see 4.6, "Location memories"), the tape located to a position between the two location memory points, and playback started from there.
- Single repeat— the display simply shows **REPEAT**— a program will be repeated; use the **DATA** dial or the **INS/+** and **DEL/-** keys to select a program number, and then press **PLAY** to start repeated play of that program. While the program is being played back, the word **REPEAT** will flash in the display. If the REPEAT setting is being made while the tape is playing back, the program which starts with the next START ID encountered during playback will be repeated.
- All repeat— the display shows **ALL REPEAT**— the complete contents of the tape will be repeated. If the REPEAT setting is being made while the tape is playing back, ALL REPEAT will start as soon as an END ID or the end of the tape is encountered.
- No repeat— the display does not show any repeat information

The number of times that the selected portion (A-B, program or tape) is repeated is set by the repeat menu option described in 3.8, "Repeat mode".

4.2 CHECK

This key [21] is used when entering characters for tape or program titles. It allows the checking of titles which are longer than the display allows, and scrolls them across the display. See "Character editing (titling)" on page 26

4.3 INS/+ and DEL/-

These keys may be used in addition to the data dial to increment and decrement values in the menus (see 3, "Menu functions").

NOTE

*Remember that menus are unshifted functions. To use these keys as increment and decrement keys in the menus, the **SHIFT** indicator must be lit, which means that the **SHIFT** key must be pressed after the menu has been entered.*

They are also used for incrementing and decrementing numeric values in the edit screens (see 4, "SHIFT functions").

When these keys are used for editing values, pressing and holding down these keys will repeat the increment or decrement operation.

When entering characters (see 4.8, "Character editing (titling)"), the **INS/+** key inserts a blank space into the character string immediately before the cursor position. The **DEL/-** key deletes the character at the cursor position.

4.4 ID markers (START, SKIP, END, CHAR and renumbering)

These ID markers are used to control tape operations when they are read on playback. Briefly:

- START IDs are nine seconds in length. They are used to mark the beginning of a program and are usually in continuous sequence (from 01 to 99). If they somehow get out of sequence, the renumber facility is used to correct this.
- SKIP IDs are one second in length, and are used in skip play mode (see **SKIP PLAY [24]**) to skip past unwanted sections of tape
- END IDs are nine seconds in length, and are used to mark the "logical" end of a tape (even though there may be tape remaining, playback will stop when an END ID is encountered). There should, naturally, only be one END ID on a tape.

The above three ID types are recognized by every kind of DAT deck and player.

This tape deck also provides another kind of subcode ID marker:

- **CHAR**, which allows the writing of alphanumeric characters (up to 60) which are associated with a START ID on the tape, which will be shown on the display when that part of the tape is replayed. These can be used as tape (if written at the first START ID) or program titles.

NOTE

All these IDs are written in the subcode of the tape— they may be written and erased freely without affecting the audio portion of the tape in any way.

4.4.1 Selecting an ID mode

Repeated presses of the **ID SELECT** key will cycle through the following options:

- **START WRT**— a START ID will be written
- **SKIP WRT**— a SKIP ID will be written
- **END WRT**— an END ID will be written
- **START ERASE**— the START ID immediately before the current location will be erased
- **SKIP ERASE**— the SKIP ID immediately before the current location will be erased
- **END ERASE**— the tape will move forward to the next END ID, which will be erased
- **CHAR ERASE**— the character information immediately before the current location will be erased
- **RENUM**— the tape will be rewound, and all START IDs will be renumbered in sequence, starting at 1.

WARNING

When one of the above ID modes is shown in the display, pressing **ENTER** may start the ID writing or editing operation. When writing or editing IDs is not required, therefore, press **ID SELECT** repeatedly until none of the above ID modes is shown on the display/

The **ERASE** and **RENUM** modes cannot be selected while the tape deck is recording.

While IDs are being written, erased or renumbered, all transport controls except **STOP** are disabled.

NOTE

If there is no cassette inserted, or if the cassette is write-protected, the message **Rec**

Protect will appear in the display when the **ID SELECT** key is pressed.

4.4.2 Manually writing a START or SKIP ID (i)

With the tape deck playing a tape where audio has previously been recorded, or recording, select either the **START WRT** or **SKIP WRT** option as described above.

When the tape reaches the point where an ID is to be written, press **ENTER** [26].

The ID will be written at the point where the **ENTER** key is pressed. While the ID is being written, **START WRT** or **SKIP WRT** (as appropriate) will flash on the display and output will be muted (if the tape deck is in playback mode).

In playback mode, the display will also show **WR-ST** or **WR-SK**, and the playback will be restored after the ID has been written.

The **PLAY** and **RECORD** indicators will both light while the ID is being written.

NOTE

Do not press the **STOP** key while writing subcode IDs. This will cause the IDs to be of indeterminate length, resulting in possible future operational problems.

4.4.3 Writing a START or SKIP ID (ii)

Use the **ID SELECT** key to choose either a START ID or a SKIP ID to write at the selected position, if the display does not already show the desired ID type.

With the tape playing, press the **POSITION** key.

The current tape location in ABS time will be displayed, together with the characters **Posit.**, showing that the **POSITION** key has been pressed.

```
0 0H 2 3M 1 7S P o s i t
```

After two seconds, the time that which the **POSITION** key was pressed will be shown to frame accuracy, together with an offset value of 00 at the right of the display.

```
0 0H 2 3M 1 7S - 1 8F 0 0
```

The **PAUSE** indicator will light, and the **PLAY** indicator will start to flash.

4 - SHIFT functions

Use the **INS/+** and **DEL/-** keys or the **DATA** dial to adjust the offset backwards or forwards by up to 50 frames in either direction.

Press **PLAY** to preview the location of the ID point. The tape will rewind to the position, with the offset added or subtracted, and start playing back from the previewed ID position. While playing back, the word **Posit** will be shown on the display. When playback stops after a few seconds, the offset value will replace the word **Posit**, and may be re-adjusted as described above.

Repeat the adjustment of the ID point and the preview of the point as many times as necessary.

When the ID point has been located satisfactorily, press **ENTER**. The display will show **WR-ST** or **WR-SK**, depending on whether a **START** or **SKIP ID** is being written.

The edited point can also be used here as a location memory (use the **MEMO 1** or **MEMO 2** key).

The writing of the ID can be canceled at any time after **POSITION** has been pressed by pressing **STOP**.

4.4.4 Writing an END ID

Writing an END ID will stop the tape. If an END ID is written in the middle of recorded material, the material following the END ID will be inaccessible until the END ID is erased.

An END ID can be written from the record, or the record pause mode.

Select the **END WRT** option as described in 4.4.1, "Selecting an ID mode".

Press **ENTER**. The END ID will be written at the point that **ENTER** is pressed.

4.4.5 Erasing a START or SKIP ID

Select the **START ERASE** or **SKIP ERASE** option as described in 4.4.1, "Selecting an ID mode".

Locate the tape to a little after the **START** or **SKIP ID** to be erased or within the ID section itself.

Press **ENTER**. The tape will move backwards to find the first appropriate ID, and **ER-ST** or **ER-SK** as appropriate is shown in the display. When the erase function is started, the tape will take some time to search for the ID and position itself appropriately.

When the ID has been located, the **START ERASE** or **SKIP ERASE** shown in the display will start flashing, and the **RECORD** and **PLAY** indicators will light.

After the ID has been erased, the deck will continue playing the tape.

NOTE

If a START ID is erased, the program numbers will not be continuous. The renumbering function may be used to restore the sequence.

4.4.6 Erasing an END ID

Select **END ERASE** as the ID mode (see 4.4.1, "Selecting an ID mode").

Move the tape to a little after the END ID, and press **ENTER**.

The tape will move back to the END ID and will erase it (the **RECORD** and **PLAY** indicators will both light). While the ID is being erased, the words **END ERASE** will flash in the display.

4.4.7 Erasing titles

If characters have been recorded on tape, the boxed word **CHAR** will appear on the bottom of the display (below the seconds digits).

To erase the characters which have been previously recorded as program titles, select **CHAR ERASE** as the ID mode (see 4.4.1, "Selecting an ID mode").

Move the tape to a little after the end of the **START ID** containing the characters to be erased,

Press **ENTER**; the display will show **ER-CH**, and the tape will start moving back until the **START ID** containing the characters is located on tape. The character information will then be erased (the **RECORD** and **PLAY** indicators will both light), but the **START ID** containing the title characters and the audio information will be retained. While the erase operation is taking place, the words **CHAR ERASE** will flash in the display.

4.4.8 Renumbering START IDs

If **START IDs** have been written to a tape after audio recording has taken place, or if **START IDs** have been removed from a sequence, the program numbers will not form a continuous series.

To renumber the programs, select **RENUM** as the ID mode.

The right side of the display will show **#01** (flashing), showing that the first **START ID** will be renumbered as 01.

You can start the tape's program numbers from a value different from 01 by turning the **DATA** dial. The program number selected with the **DATA** dial will flash (the flashing will continue for five seconds).

Confirm the flashing program number with the **ENTER** key. If you press **ENTER** after the program number has stopped flashing, renumbering will start from 01.

The tape will rewind to the first START ID, and rewrite the ID in the same location as previously, but with the number selected above.

When this is done, the number at the right of the display will change to the number which is one greater than the starting program number, and the tape will move forward to the next START ID and renumber it in the same way.

While a START ID is being rewritten, the word **RENUM** will flash in the display, and the **PLAY** and **RECORD** indicators will light.

If the current START ID already has a number, this will be shown to the left of the # mark on the display:

```

PNO
0 0H 2 3M 1 7S 0 2 # 0 3
    
```

If the current START ID is unnumbered, this is represented by a pair of dashes in the **PNO** location on the display.

All program titles are retained during the renumbering process.

The renumbering process continues until the end of the tape or an END ID is reached.

NOTE

Valid program numbers are from 01 to 99. If the above procedure is used to select a program number at the high end of the range, and the renumbering increments a program number above 99, the number will "wrap" to 00. The number 00 can cause problems when searching and locating, and this should be remembered when setting program numbers.

4.5 The EDIT key

The **EDIT** key (**SHIFT**ed **MENU [27]**) allows the following operations to be performed:

- Editing of the first memory location
- Editing of the second memory location
- Editing of a programmed sequence of programs for subsequent playback
- Editing of a string of characters to be used as a tape or program title
- Writing a string of characters to tape

Repeated presses of **EDIT** will cycle through these options.

To exit the EDIT mode, press **COUNTER MODE** or **DISPLAY** (as with all **SHIFT**ed modes, pressing the **SHIFT** key so that the **SHIFT** indicator goes out will exit the **SHIFT** mode).

The **ENTER** key is used to select the operation.

4.6 Location memories

4.6.1 Locating to location memories

Once a memory location has been set, as explained below, use the **LOC 1** and **LOC 2** keys to locate to the memory location points (as explained in **LOC 1 [28]**).

4.6.2 Setting location memories

Press the **MEMO 1** or **MEMO 2** key. The current location will be stored to frame accuracy, regardless of whether or not the frame display mode is currently in operation, in memory location 1 or 2 as appropriate.

4.6.3 Editing location memories

Press **EDIT** until the display shows either **M1?** or **M2?** at the right, together with the location value stored in that location memory.

```

0 0H 2 8M 5 3S 2 9 M 1 ?
    
```

Press **ENTER** to start editing the location memory. The word **Edit** will appear at the right of the display, and the right digit of the frames field will start to flash.

```

0 0H 2 8M 5 3S 2 9 E d i t
    
```

Use the **SHUTTLE** wheel to move the cursor (flashing digits) between the frames, seconds, minutes and hours fields.

Use the **INS/+** and **DEL/-** keys and the **DATA** dial to increment or decrement the flashing value field.

4 - SHIFT functions

4.7 Program mode

To play back a selection of programs in a defined order, press **EDIT** until the following is shown on the display:

```
E d i t   P R G M   ?
```

NOTE

The program numbers for programmed playback are taken from the START IDs. If there are no START IDs recorded on the tape, or if they are out of sequence, programmed playback may not produce the expected results! The RENUM function (4.4.8, "Renumbering START IDs") should be used to restore the sequence.

Press **ENTER** to start editing the program steps:

```
S t e p 0 1 P n o   E E
```

Use the **DATA** dial to choose a program number (shown at the right of the display).

Use the **SHUTTLE** wheel to choose the program step number. There may be up to 30 steps in a programmed playback sequence.

Enter the last program step with the program number **EE** (end of tape) by pressing the **DEL/-** key.

When the program numbers have been entered into the program steps, press **PLAY**. The word **PROGRAM** appears in red at the bottom of the display.

The tape will locate to the program number specified in the first program step, and will then start playing. When the START ID following the first program in the list is encountered, the tape will then move to the next program number specified in the program list.

This process continues until all steps in the program have been played.

The **PAUSE** key can be used to play back a series of program steps, one at a time, in the following way:

If the **PAUSE** key is pressed after the program steps have been entered, the tape will locate to the start of the program number specified in the first step, and will enter pause mode.

Following this, if the **PLAY** key is pressed, the first program step will be played, and the tape will locate to the start of the next program step and enter pause mode until the **PLAY** key is pressed again. The process continues until all program steps have been played back.

Pressing either of the **SKIP** keys during programmed playback will move the tape to the start of the current or next (as appropriate) program step.

If playback is stopped in the middle of programmed playback, the program will be canceled, and the word **PROGRAM** will disappear from the display.

Programs cannot be stored for further reference.

4.8 Character editing (titling)

Using this feature, tape and program titles can be added to the subcode of the tape, which are displayed on the alphanumeric display of the tape deck.

These titles are written at a point that coincides with START IDs. This allows them to be associated easily with program names.

NOTE

This feature is not supported by every DAT player and recorder. If titles are recorded on a tape, they will be shown on some other models of TASCAM machines, but not on other recorders. However, recording titles will not affect the audio quality or any other aspect of the tape when it is used on other recorders.

4.8.1 Entering and editing titles

Press **EDIT** until the display shows:

```
E d i t   C h a r   ?
```

Press **ENTER** to start editing the character string. Up to 60 characters can be entered.

The **SHUTTLE** wheel is used as a cursor to move left and right through the string (the cursor position is marked by a flashing character at the cursor position— if no character is visible at the cursor position, the cursor changes to a flashing block).

The **DATA** dial is used to change the character. The characters available are:

A through Z, a through z, 0 through 9 and the following punctuation symbols: # ; < = > ? @ !

" # \$ % & ' () * + , - . / _ and the space character.

To change between uppercase and lowercase alphabetical characters, use the **CAPS** key. The word **CAPS** appears at the bottom left of the display when the "caps lock" is on.

The **INS/+** and **DEL/-** keys are used to insert a space immediately following the cursor position, and to delete the character at the cursor position, respectively.

Since the title can be longer than the display can show at one time, the first characters of the title are shown, and the rest is then scrolled from right to left.

4.8.2 Writing the title to tape

Locate the tape to a point following the end of the START ID which will be associated with the title that has just been entered.

Press **EDIT** until the display shows:

```
W r i t e   C h a r   ?
```

Press **ENTER**, and the tape will start moving back until before the start of the previous START ID, and then start recording the characters. The words **CHAR WRT** will flash in the display while recording is taking place.

4.8.3 Checking a title

When replaying a tape on which titles have been recorded, the boxed word **CHAR** appears under the seconds field at the bottom of the display as soon as the first title is read from tape.

Use the **CHAR** key to display the last title which has been read from tape. While the title is displayed, all other tape counter numerals are replaced by the characters in the title. The title will scroll across the display if it is too long to fit in the display.

4.8.4 Deleting a title

Locate the tape to a little past the point where the title is recorded on tape.

Use the **ID SELECT** key to select the **CHAR ERASE** mode (4.4.1, "Selecting an ID mode").

Press **ENTER**. The display will show **ER-CH**, and the tape will rewind to a little before the point where the title has been recorded.

The title will then be erased. The words **CHAR ERASE** will flash in the display while the title is actually being erased.

4.8.5 Copying and pasting a title

The title which was last been read from tape can be copied and used as the basis for new titles. This can be useful if you are producing a lot of programs with similar titles (different mixes or takes of the same piece, for instance).

Once the title which will be copied has been read from tape (the **CHAR** indicator in the display must be lit), press **EDIT** until the display shows:

```
E d i t   C h a r   ?
```

Press the **MEMO 2** key to recall and paste the last title into the editing area. The title may then be edited and written to tape in the usual way.

5 - RC-D45 remote control unit (option)

The optional RC-D45 remote control unit is plugged into the **REMOTE IN [35]** jack at the rear of the tape deck.

Most of the controls on the remote control unit duplicate the controls on the main tape deck. The explanation of the controls is given below:

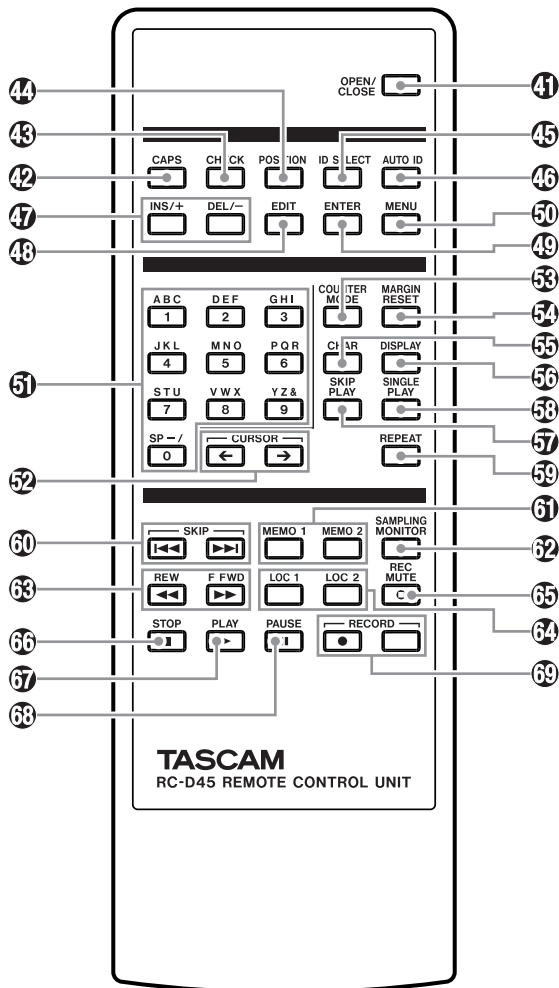

[41] OPEN/CLOSE

Equivalent to **[2]** on the main unit.

[42] CAPS

Equivalent to the shifted **SINGLE PLAY [30]** key on the main unit. Used to toggle between uppercase and lowercase when entering titles (see 4.8.1, "Entering and editing titles").

[43] CHECK

Equivalent to the shifted **CHAR [21]** on the main unit.

[44] POSITION

Equivalent to the shifted **SKIP PLAY [24]** on the main unit.

[45] ID SELECT

Equivalent to the shifted **AUTO ID [25]** on the main unit.

[46] AUTO ID

Equivalent to the **AUTO ID [25]** on the main unit.

[47] INS/+ and DEL/-

Equivalent to the shifted **MARGIN RESET [22]** and **DISPLAY [23]** on the main unit.

[48] EDIT

Equivalent to the shifted **MENU [27]** on the main unit.

[49] ENTER

Equivalent to the **ENTER [26]** on the main unit.

[50] MENU

Equivalent to the **MENU [27]** on the main unit.

[51] Numeric keys

These keys may be used for a variety of purposes.

When playing back a tape, entering a program number using these keys, and pressing **PLAY** will locate the tape to that program and start playing. If **PAUSE** is pressed rather than **PLAY**, the tape will be located to the start of the program and the deck will enter pause mode.

When editing and entering titles, these keys may be used as a convenient way of entering characters. Repeated presses of a key will cycle through the characters associated with the key. For instance, the **2** key, when pressed once, will enter **2** in the title. Pressing it again will enter **∅** (or **D** if the **CAPS** mode is active), pressing it one more time will enter **∞** and pressing it again will enter **f**. If it is pressed one more time, it will enter **∫**.

[52] Cursor keys

These keys are used to move the cursor left and right when entering and editing program titles.

[53] COUNTER MODE

Equivalent to the **COUNTER MODE [20]** on the main unit.

[54] MARGIN RESET

Equivalent to the **MARGIN RESET [22]** on the main unit.

[55] CHAR

Equivalent to the **CHAR [21]** on the main unit.

[56] DISPLAY

Equivalent to the **DISPLAY** [23] on the main unit.

[57] SKIP PLAY

Equivalent to the **SKIP PLAY** [24] on the main unit.

[58] SINGLE PLAY

Equivalent to the **SINGLE PLAY** [30] on the main unit.

[59] REPEAT

Equivalent to the shifted **COUNTER MODE** [20] on the main unit.

[64] LOC 1 and LOC 2 keys

Equivalent to the **LOC 1** [28] and **LOC 2** [29] on the main unit.

[65] REC MUTE

Equivalent to the **REC MUTE** key [17] on the main unit.

[66] STOP

Equivalent to the **STOP** key [13] on the main unit.

[67] PLAY

Equivalent to the **PLAY** key [14] on the main unit.

[68] PAUSE

Equivalent to the **PAUSE** key [15] on the main unit.

[69] RECORD keys

To enter record ready, both of these keys must be pressed simultaneously. It is not possible to enter record mode directly, and this helps to prevent accidental recording.

5.1 Remote control transport keys

[60] SKIP keys

Equivalent to the **SKIP** keys [11] on the main unit.

[61] MEMO 1 and MEMO 2 keys

Equivalent to the shifted **LOC 1** [28] and **LOC 2** [29] on the main unit.

[62] SAMPLING MONITOR key

Equivalent to pressing the **RECORD** key on the main unit once (see 16, "RECORD key").

[63] REW and F FWD

Equivalent to the **REW** and **F FWD** keys [12] on the main unit.

6 - Specifications

6.1 Audio specifications

Tape Speed	8.15 mm/s (SP mode)
	4.075 mm/s (LP mode)
Recording time (with 120-minute cassette)	120 minutes (SP mode)
	240 minutes (LP mode)
Head drum speed	2,000 rpm (SP mode)
	1,000 rpm (LP mode)
Fast wind time (forward and rewind)	60 seconds end-to-end with 120-minute tape
Sampling frequency	44.1 kHz, 48 kHz
	32 kHz (LP mode)
Recording resolution	16-bit linear (SP mode)
	12-bit non-linear (LP mode)
Frequency response ± 0.5 dB	20 Hz to 20,000 Hz (SP mode)
	20 Hz to 14,500 Hz (LP mode)
S/N ratio	> 92 dB
Dynamic range	>93 dB
Total harmonic distortion (1 kHz @ FS – 0.1 dB)	<0.005% (SP mode)
	<0.075% (LP mode)
Channel separation	>90 dB (1kHz @ FS)
Wow and flutter	Unmeasurable (<0.001%)

6.2 I/O specifications

Analog inputs (balanced XLR-3-31 type)	Nominal input level +4dBu (FS=–16 dBu) Maximum input level +20 dBu Nominal impedance >10 k Ω
Analog inputs (unbalanced RCA)	Nominal input level –10dBV Maximum input level +6 dBV (2Vrms) Nominal impedance >50 k Ω
Analog outputs (balanced XLR-3-32 type)	Nominal output level +4dBu (FS=–16 dBu) Maximum output level +20 dBu Nominal impedance <100 Ω

Analog outputs (unbalanced RCA)	Nominal output level –10 dBV Maximum output level +6 dBV (2 Vrms) Nominal impedance <1k Ω
Headphone 1/4-inch stereo jack	(2 x 50 mW into 32 Ω)
Digital input AES/EBU (balanced XLR-3-31 type)	AES3-1992 (Type I) ^a or IEC60958 format (Type II) (auto-detect)
Digital input COAXIAL (unbalanced RCA)	AES3-1992 (Type I) ^a or IEC60958 format (Type II) (auto-detect)
Digital output AES/EBU (balanced XLR-3-32 type)	AES3-1992 (Type I) ^a or IEC60958 format (Type II) (menu-selectable)
Digital output COAXIAL (unbalanced RCA)	AES3-1992 (Type I) ^a or IEC60958 format (Type II) (menu-selectable)
Parallel I/O port	15-pin 'D'-sub connector
REMOTE CONTROL 3.5 mm mini-jack	For use with RC-D45 only

- a. IEC-60958 Type I (AES3-1992) is a standard for broadcasting studios (professional). It cannot be used for connecting consumer products. IEC-60958 Type II (SPDIF) is a standard for consumer products.

6.3 Physical specifications

Voltage requirements:	USA/Canada 120 VAC '60 Hz Europe/UK 230 VAC @ 50 Hz Australia 240 VAC @ 50 Hz
Power consumption	21 W
Weight	8 kg (17.6 lbs)
Dimensions (w x h x d)	482 x 150.5 x 364 mm (19 x 5.9 x 14.3 in)
Supplied accessories	Rack mounting kit
Optional accessories	RC-D45 wired remote control unit

Changes to specifications and features may be made without notice or obligation.

6.4 Dimensional drawing

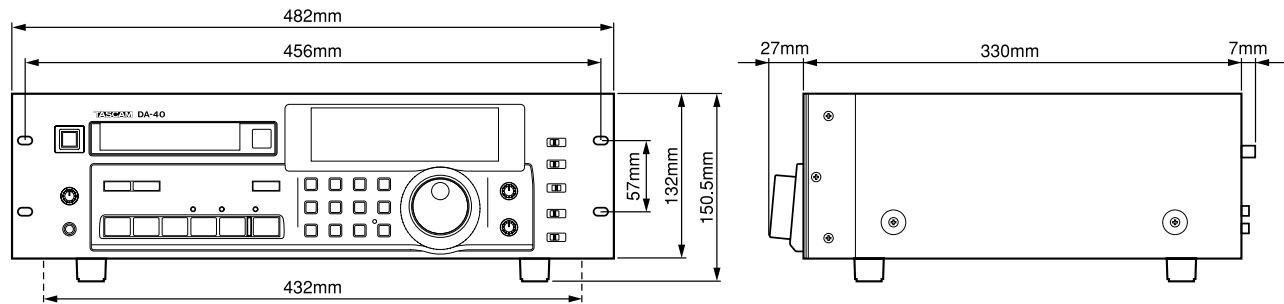

6.5 Error messages

There are two types of error message: warning (informational) and more serious messages.

6.5.1 Warning messages

These simply give an indication of a situation which is easily resolved:

AES/EBU X—The digital audio signal received at the **AES/EBU** input has been selected as an input source, but has become unsynchronized or is not present.

COAXIAL X—The digital audio signal received at the **COAXIAL** unbalanced input has been selected as an input source, but has become unsynchronized or is not present.

AES/EBU ?—The digital audio signal received at the **AES/EBU** balanced input is more than 0.1% outside the standard sampling frequency and cannot be recorded (though it can be monitored).

COAXIAL ?—The digital audio signal received at the **COAXIAL** unbalanced input is more than 0.1% outside the standard sampling frequency and cannot be recorded (though it can be monitored).

Tape Top & Tape End—The tape is at the start or end, and an attempt has been made to move past this point

End-ID—The presence of the END ID prevents the attempted operation

TapeMode HR—The inserted tape has been recorded in 24-bit mode on a TASCAM DA-45HR machine, or the inserted tape is not intended for the DA-40. If this message appears, the inserted tape cannot be played back on the DA-40.

RecProtect—The cassette's sliding write-protect tab is in the write-protect position.

6.5.2 Serious error messages

Any of the following error messages indicates a serious error, which you should never see in normal operation. If any of these appears, first try any countermeasures listed here. If the message does not disappear after trying the countermeasure, you should contact your TASCAM distributor for testing and repair of your tape deck.

DSP Com. Err.

Mecha. Com. Er.

Loading Err—Eject the tape, power down the tape deck, power it up again, and reinsert the tape as described in 1.4, "About DAT cassettes". If this fails, contact your TASCAM dealer.

Drum Error—Condensation may have occurred on the head drum. Remove the cassette, and leave the tape deck switched on for one or two hours. See the warning note in 1.3, "Installation of the tape deck"

Capstan Error

SUMemo.RDE

SUMemo.WRE

Tape Cut!—The tape has broken. You may be able to remove the damaged cassette, but this is usually best left to a qualified service technician, as the tape may be wound in a complex path around delicate mechanical parts of the tape deck.

Memo.Data Er—The memorized menu settings (3.13, "Parameter save") are no longer stored in memory. Try re-making these settings. If the problem persists, contact your TASCAM dealer.

A

A-B repeat 22
ABS time 14
Adjusting output levels 17
AES/EBU 11
AES/EBU connections 7
AES/EBU output 19
All repeat 22
Analog connections 7
AUTO ID 18
Auto play 12
Auto rewind 20

B

Balanced connections 7, 11, 16
 selection 11
Balanced inputs 16
Balanced outputs 17
Block error rate display 18
Block error rate display mode 15

C

Calibrated input 11
CAPS key 26
CHAR
 see "Tape and program titles"
Cleaning the heads 7
Condensation 6
CONTROL I/O connector 8, 16, 20
Copy protection 19
Copying and pasting a title 27
Counter modes 14
Cue and review 12
Cueing tapes 13
Cursor keys (on remote control) 28

D

DAT cassettes
 loading and unloading 10
 precautions 6
 remaining time 14
DATA dial
 Locating to track numbers 13
dd setting (digital detect of track start) 18
Default parameters 20
Default settings 20
Digital audio connections 7
Digital audio input 11
Display 10
Display mode 14
Drum head time 18

E

END ID 19, 20, 22

 erasing 24
 recording 24
End tally signal 20
ENTER key 15
Environmental considerations 6
Error messages 31

F

Fast forward 12
4-digit counter mode 14
Frames display mode 14
Fs switch 11

H

Head cleaning 7
Head time 18
Headphones 11
Headroom 14

I

ID modes 23
Initializing settings 20
Input level 11
Input monitor 12
Input selection 11

L

Loading cassettes 10
LOC 1 and LOC 2 keys 15
Locating to memory locations 15, 25
Locating to track numbers 11
Location memories 25
Location, pre-roll times 19
Long play mode 10
 recording sources 10
 sampling frequency 10, 11
LP mode 10
 tape time 10

M

Margin display mode 14
Margin reset 14
Memory locations, editing 25
Menu functions 18
MENU key 15
Meters 10, 12
Muting input 13, 19

N

Number keys (on remote control) 28

O

OPEN/CLOSE button 10
Operating environment 6

Output format *19*
 Output levels, adjusting *17*

P

Pause *12*
 PGM time *14*
 Phones *11*
 Playback *12*
 Position key *23*
 Power switch *10*
 Pre-roll value *19*
 Program number *25*
 Program number display mode *14*
 Program time *14*
 Programmed playback *22, 26*

R

Rack mounting *6*
 RCA connectors *7, 11*
 RC-D45 remote control unit *7, 16, 28*
 REC MUTE *13*
 Record keys (on remote control) *29*
 Record mute *19*
 Record ready *12*
 Recording procedure *12*
 Remaining time *14*
 Remote control unit *7*
 Renumbering *23, 24*
 Repeat mode *19, 22*
 Rewind *12*
 "Rock and roll" cueing *13*

S

Sampling frequency *10, 11, 12*
 in LP mode *10, 11*
 in SP mode *11*
 indication when recording *12*
 with digital recording *11*
 SCMS *19*
 Shift key *16*
 Shuttle wheel *13*
 Single play mode *15*
 Single repeat *22*
 SKIP ID *15, 22, 24*
 erasing *24*
 recording *23*

Skip keys *11*
 Skip play *15*
 SP mode *10*
 SPDIF *11*
 SPDIF connections *7*
 SPDIF output *19*
 Specifications *30*
 Standard levels *11*
 Standard output trimmer position
 Output trimmers *17*
 Standard play mode *10*
 Standard rack mounting *6*
 START ID *11, 14, 18, 22*
 erasing *24*
 recording *23*
 renumbering *24*
 START ID, AUTO ID *15*
 Stop mode *12*
 Storing settings *20*

T

Tape and program titles *14*
 "Caps lock" *26*
 CHAR markers *23*
 checking *22, 27*
 deleting *27*
 entering and editing *26*
 erasing *24*
 recording on tape *27*
 Tape counter modes *14*
 Titling
 see "Tape and program titles"
 Transport logic *11*
 "Trimmer pots" (balanced outputs) *17*

U

Unbalanced connections *7, 11, 16*
 selection *11*
 Unbalanced inputs *16*
 Unbalanced outputs *16*
 Uncalibrated input *11*
 Unloading cassettes *10*

X

XLR connectors *7, 11*

TASCAM

TEAC Professional Division

DA-40

TEAC CORPORATION

Phone: (0422) 52-5082

3-7-3, Nakacho, Musashino-shi, Tokyo 180-8550, Japan

TEAC AMERICA, INC.

Phone: (323) 726-0303

7733 Telegraph Road, Montebello, California 90640

TEAC CANADA LTD.

Phone: 905-890-8008 Facsimile: 905-890-9888

5939 Wallace Street, Mississauga, Ontario L4Z 1Z8, Canada

TEAC MEXICO, S.A. De C.V

Phone: 5-658-1943

Privada De Corina, No.18, Colonia Del Carmen Coyoacan, Mexico DF 04100

TEAC UK LIMITED

Phone: 01923-819699

5 Marlin House, Marlin Meadow, The Croxley Centre, Watford, Herts. WD1 8YA, U.K.

TEAC DEUTSCHLAND GmbH

Phone: 0611-71580

Bahnstrasse 12, 65205 Wiesbaden-Erbenheim, Germany

TEAC FRANCE S. A.

Phone: 01.42.37.01.02

17 Rue Alexis-de-Tocqueville, CE 005 92182 Antony Cedex, France

TEAC BELGIUM NV/SA

Phone: 0031-30-6048115

P.A. TEAC Nederland BV, Perkinsbaan 11a, 3439 ND Nieuwegein, Netherlands

TEAC NEDERLAND BV

Phone: 030-6030229

Perkinsbaan 11a, 3439 ND Nieuwegein, Netherlands

TEAC AUSTRALIA PTY.,LTD. A.C.N. 005 408 462

Phone: (03) 9644-2442

106 Bay Street, Port Melbourne, Victoria 3207, Australia

TEAC ITALIANA S.p.A.

Phone: 02-66010500

Via C. Cantù 11, 20092 Cinisello Balsamo, Milano, Italy